

S&P Global Ratings Credit Update

Ben Gallovic – Associate Director
Local Governments – Central Region
U.S Public Finance

Ohio Government Finance Officers Association

October 6, 2022



S&P Global
Ratings

Agenda

- Rating Transitions & Trends: Ohio vs. U.S.
- Macroeconomic Update: Impact on Local Governments
- Hot Topics: ESG, Pensions, & Cyber
- Q&A
- Appendix

Rating Transitions & Trends: Ohio vs. U.S.

USPF Rating Changes By Sector (2020)

	Upgrade (%)	Downgrade (%)	Default (%)	Upgrades	Downgrades	Defaults
Local governments*	0.54	2.98	0	94	520	0
Tax secured	0.59	2.32	0	77	302	0
Appropriation	0.38	4.93	0	17	218	0
Utility	1.64	2.27	0	39	54	0
Higher education	0.66	8.59	0.13	5	65	1
Health care	1.32	7.51	0	6	34	0
Transportation	1.67	34.11	0	5	102	0
Charter schools	1.42	6.05	0	4	17	0
Nonhousing	0.71	3.67	0	153	792	1
Housing	2.88	6.18	0.57	61	131	12

*Includes tax secured and appropriations. Sources: S&P Global Ratings Research and S&P Global Market Intelligence's CreditPro®.

USPF Rating Changes By Sector (2021)

	Upgrades (%)	Downgrades (%)	Defaults (%)	Upgrades	Downgrades	Defaults
Local governments*	2.09	0.93	0	366	162	0
Tax secured	2.16	0.9	0	282	117	0
Appropriation	1.89	1.01	0	84	45	0
Utility	2.88	2.21	0.04	69	53	1
Higher education	1.93	2.96	0.13	15	23	1
Health care	4.43	4.88	0	20	22	0
Transportation	10.24	0.34	0	30	1	0
Charter schools	4.7	2.68	0.34	14	8	1
Nonhousing	2.37	1.24	0.01	514	269	3
Housing	1.58	1.35	0.23	34	29	5

Note: Downgrades exclude defaults. *Includes tax secured and appropriations. Sources: S&P Global Ratings Research and S&P Global Market Intelligence's CreditPro®.

Upgrades outpace downgrades in 2021

Upgrade, Downgrade, And Default Ratios By Sector (2021)

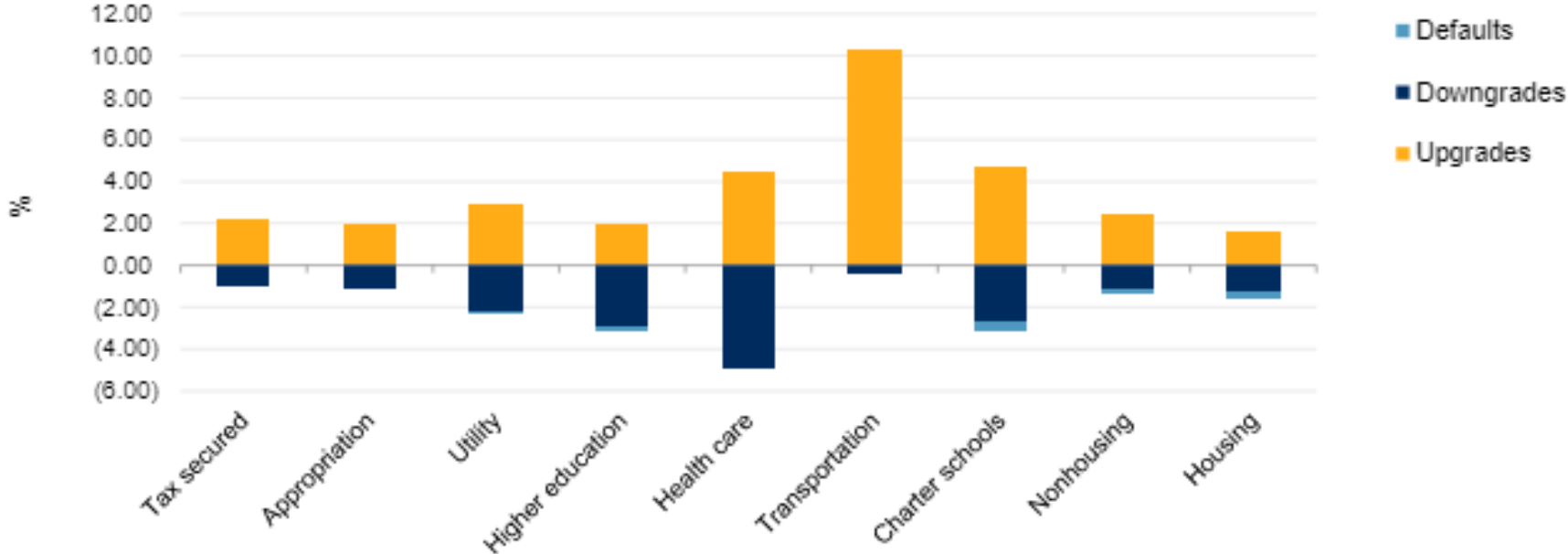

Source: S&P Global Ratings Research.
Copyright © 2022 by Standard & Poor's Financial Services LLC. All rights reserved.

Local Government Rating Transition Rates

Average One-Year Transition Rates By Sector (1986-2021) (%)									
Rating	AAA	AA	A	BBB	BB	B	CCC/C	D	NR
Tax secured									
AAA	97.50	1.07	0.03	0.01	0.00	0.00	0.00	0.00	1.38
AA	0.84	95.73	0.76	0.03	0.00	0.00	0.00	0.00	2.63
A	0.01	2.81	92.69	0.52	0.03	0.02	0.00	0.00	3.92
BBB	0.00	0.22	6.68	87.18	0.51	0.16	0.07	0.01	5.18
BB	0.00	0.00	0.89	10.84	74.87	2.17	1.53	0.00	9.69
B	0.00	0.35	1.05	4.21	10.88	67.37	5.96	1.05	9.12
CCC/C	0.00	0.00	4.55	1.82	4.55	8.18	55.45	13.64	11.82
Appropriation									
AAA	91.87	2.66	0.00	0.00	0.00	0.00	0.14	0.00	5.33
AA	0.12	89.75	1.70	0.01	0.00	0.01	0.00	0.00	8.40
A	0.00	3.73	86.81	1.31	0.03	0.00	0.02	0.00	8.08
BBB	0.00	0.15	8.33	81.02	1.24	0.09	0.16	0.00	9.01
BB	0.00	0.00	3.04	7.60	66.26	2.74	6.69	1.82	11.85
B	0.00	0.00	0.00	4.12	4.12	65.98	6.19	5.15	14.43
CCC/C	0.00	0.00	0.00	1.03	1.03	5.15	43.30	26.80	22.68

Source: S&P Global Ratings Research.

Relative Ratings Performance

USPF Nonhousing One-Year Rating Lorenz Curve (1986-2021)

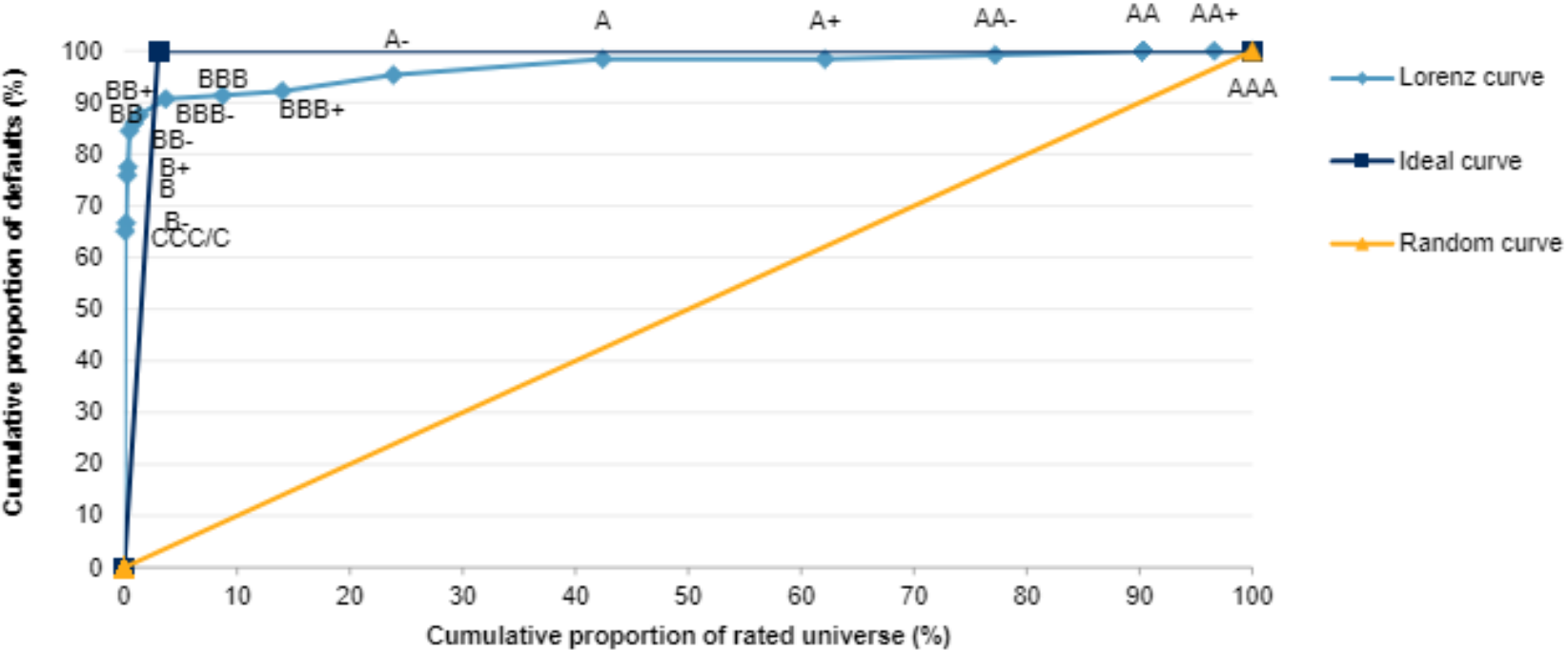

Source: S&P Global Ratings Research.
 Copyright © 2022 by Standard & Poor's Financial Services LLC. All rights reserved.

Ohio Rating Actions Since March 2020

Action	Total
Downgrade	4
Downgrade + Negative outlook revision	3
Downgrade + CreditWatch Negative	1
Downgrade + Stable outlook revision	2
Negative outlook revision	4
CreditWatch Negative	2
Upgrade	1
Stable outlook revision	6
Total	23

Includes GO Muni and County, & Priority Lien ratings
n=125 ratings

Source: S&P Global Ratings

Negative Actions: 70% of Total

- 63% Financial
- 50% COVID
- 38% Debt
- 31% Management

Positive Actions: 30% of Total

- 100% Financial
- 14% Management

About 90% of portfolio saw no rating or outlook change since March 2020

Current Outlooks

Ohio Municipalities & Counties

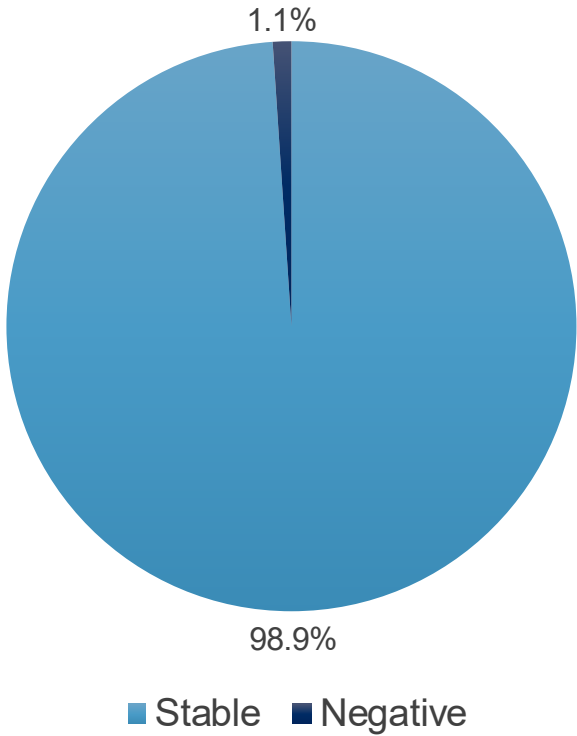

U.S. Municipalities & Counties

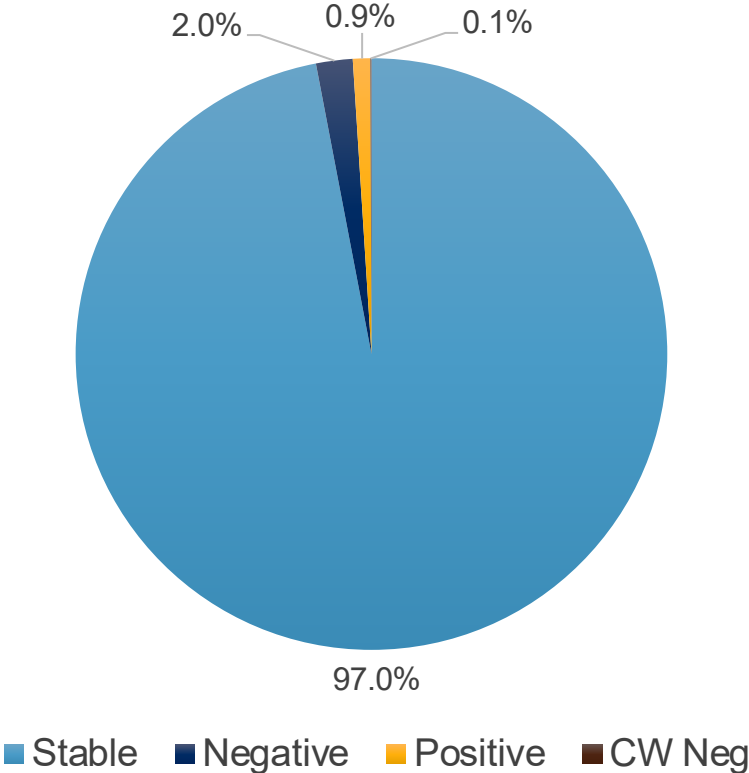

Source: S&P Global Ratings

Municipality General Obligation Rating Distribution

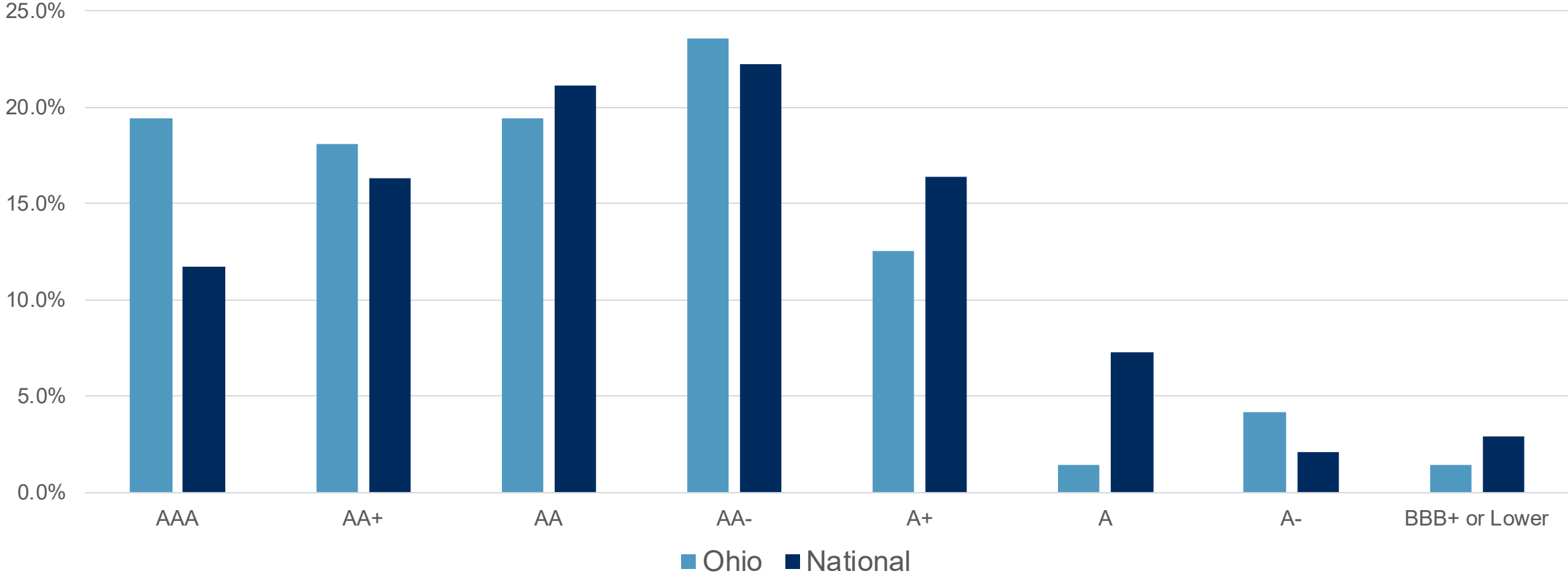

Source: S&P Global Ratings

Ohio Municipalities: Medians

	AAA	AA+	AA	AA-	A+	A	A-	BBB+ or Lower
Projected per capita EBI (%)	170%	112%	97%	83%	77%	71%	66%	47%
Market value per capita (\$)	140,351	93,325	75,690	55,062	53,453	44,832	35,654	33,618
Available general fund (%)	117%	108%	74%	71%	55%	37%	2%	81%
General fund performance (%)	19.0%	17.1%	9.6%	10.3%	10.1%	9.8%	14.2%	24.9%
Cash and expense (%)	143%	120%	112%	95%	92%	161%	12%	43%
Carrying charge (%)	8.9%	4.8%	4.9%	5.5%	8.7%	7.0%	5.6%	1.6%
Pension ARC + OPEB as % expense	5.4%	6.7%	7.7%	7.6%	7.8%	9.0%	8.6%	9.2%
EBI--Effective buying income. ARC--Annual required contribution. OPEB--Other postemployment benefits. As of September 11, 2022								

U.S. Municipalities: Medians

	AAA	AA+	AA	AA-	A+	A	A-	BBB+ or Lower
Projected per capita EBI (%)	163%	123%	101%	84%	75%	70%	67%	69%
Market value per capita (\$)	218,497	152,485	113,727	81,512	62,452	50,386	46,709	50,275
Available general fund (%)	41%	40%	46%	53%	48%	39%	30%	15%
General fund performance (%)	3.2%	4.3%	5.1%	4.7%	5.3%	4.9%	4.1%	2.5%
Cash and expense (%)	74%	79%	88%	96%	90%	80%	64%	44%
Carrying charge (%)	6.4%	6.1%	7.4%	7.8%	8.8%	8.6%	8.9%	9.0%
Pension ARC + OPEB as % expense	6.0%	6.0%	6.2%	5.1%	4.8%	4.6%	4.3%	7.9%
EBI--Effective buying income. ARC--Annual required contribution. OPEB--Other postemployment benefits. As of September 11, 2022								

S&P Global Ratings Source: S&P Global Ratings

County General Obligation Rating Distribution

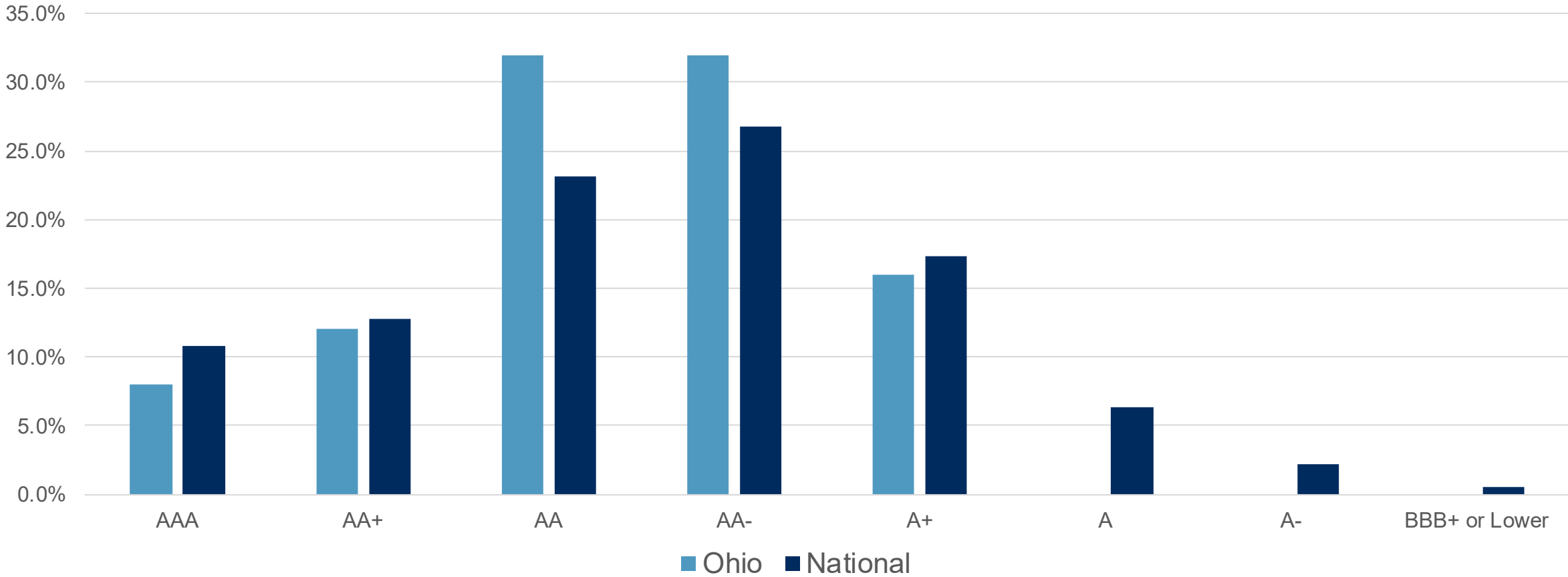

Source: S&P Global Ratings

Ohio Counties: Medians

	AAA	AA+	AA	AA-	A+
Projected per capita EBI (%)	128%	107%	90%	79%	65%
Market value per capita (\$)	94,099	96,399	75,390	73,223	59,199
Available general fund (%)	66%	60%	78%	54%	58%
General fund performance (%)	8.5%	16.3%	19.2%	12.1%	22.1%
Cash and expense (%)	58%	95%	97%	104%	75%
Carrying charge (%)	3.3%	1.9%	2.1%	2.9%	1.9%
Pension ARC + OPEB as % expense	4.3%	5.0%	4.7%	5.1%	4.9%
EBI--Effective buying income. ARC--Annual required contribution. OPEB--Other postemployment benefits. As of September 11, 2022					

U.S. Counties: Medians

	AAA	AA+	AA	AA-	A+	A	A-	BBB+ or Lower
Projected per capita EBI (%)	116%	97%	86%	75%	70%	68%	73%	47%
Market value per capita (\$)	151,780	121,867	106,776	91,826	74,779	63,738	59,634	51,041
Available general fund (%)	33%	47%	53%	52%	48%	44%	22%	39%
General fund performance (%)	5.3%	7.9%	7.7%	6.4%	8.9%	7.0%	6.1%	13.6%
Cash and expense (%)	64%	74%	70%	67%	59%	54%	25%	43%
Carrying charge (%)	6.1%	5.2%	5.1%	4.9%	5.2%	5.6%	7.3%	10.6%
Pension ARC + OPEB as % expense	4.3%	4.3%	4.2%	3.2%	3.2%	3.1%	3.2%	4.6%
EBI--Effective buying income. ARC--Annual required contribution. OPEB--Other postemployment benefits. As of September 11, 2022								

Financial Management Assessment (FMA)

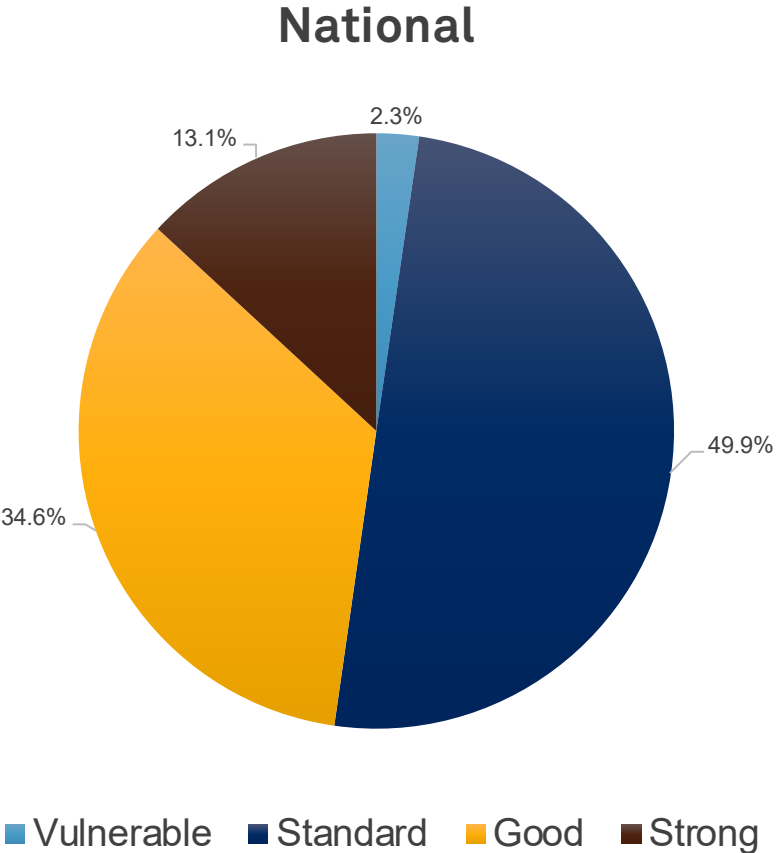
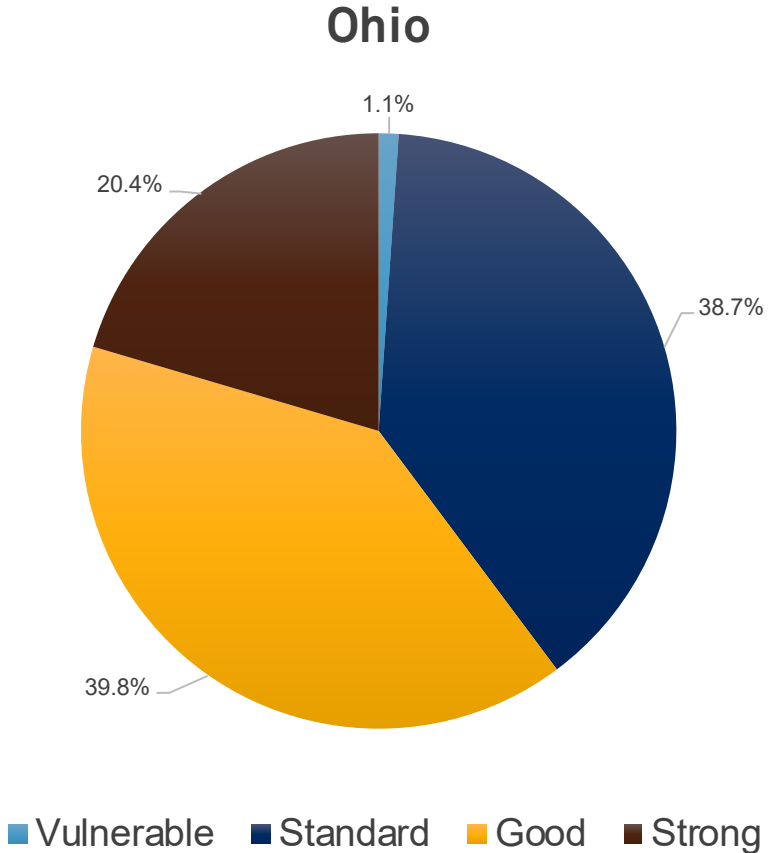

Macroeconomic Update: Impact on Local Governments

S&P Economics' Assessment of Recession Risk

Leading Indicators Growth Signal Heatmap As Of August 2022

Leading indicators	Latest data											
	May-20	Feb-21	May-21	Nov-21	Jan-22	Feb-22	Mar-22	Apr-22	May-22	Jun-22	Jul-22	Aug-22
Term spread	Neutral	Positive	Positive	Neutral	Positive	Positive	Positive	Positive	Positive	Positive	Neutral	Neutral
Credit spread	Negative	Positive	Positive	Positive	Positive	Positive	Neutral	Neutral	Neutral	Neutral	Neutral	Neutral
S&P 500	Positive	Positive	Positive	Positive	Negative	Negative	Neutral	Negative	Negative	Negative	Negative	Negative
Key element: Expectations of the financial market on future economic conditions												
Consumer sentiment	Negative	Neutral	Neutral	Neutral	Neutral	Neutral	Negative	Negative	Negative	Negative	Negative	Neutral
Key element: Consumers' willingness to purchase, especially durables												
Jobless claims-adjusted by labor force	Negative	Negative	Negative	Positive	Positive	Positive	Positive	Positive	Positive	Positive	Positive	Positive
Freight transportation index-annual growth rate	Negative	Neutral	Positive	Positive	Positive	Positive	Positive	Positive	Positive	Positive	N.A	N.A
Key element: Rapid response to changing business conditions												
Building permits (single-family)-annual growth rate	Negative	Positive	Positive	Neutral	Neutral	Positive	Neutral	Neutral	Negative	Negative	Negative	N.A
ISM (MFG) new orders index	Negative	Positive	Positive	Positive	Neutral	Positive	Neutral	Neutral	Positive	Negative	Negative	N.A
Key element: Leading real production activities down the pipeline												
Fed's loan survey	Negative	Neutral	Neutral	Positive	Positive	Positive	Positive	Neutral	Neutral	Neutral	Negative	Negative
Chicago Fed NFCI Index	Negative	Positive	Positive	Positive	Positive	Neutral	Neutral	Neutral	Negative	Negative	Negative	Negative
Key element: Availability of credit and level of financial stress of the real sector												

Data through Aug. 30. N.A.--Not available. Source: S&P Global Ratings Economics. Copyright © 2022 by Standard & Poor's Financial Services LLC. All rights reserved.

- 6 of 7 indicators in August were negative or neutral
- Within one year of last three recessions, proportion of non-positive signals > 60%

Increase In Probability Of Recession Over The Past Year

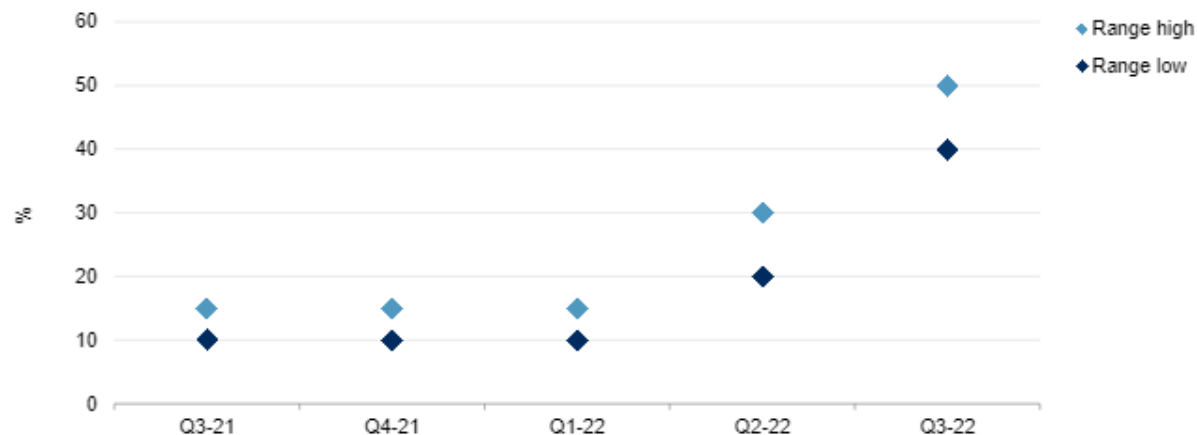

Copyright © 2022 by Standard & Poor's Financial Services LLC. All rights reserved.

- Qualitative recession risk over next 12 months is currently at 45%
- Could reach 50% going into 2023
- Duration, depth, but not yet dispersion

Labor shortage & inflation pressures

Men's Labor Force Participation Is Recovering Faster Than Women's

Pre-pandemic trend vs. current conditions

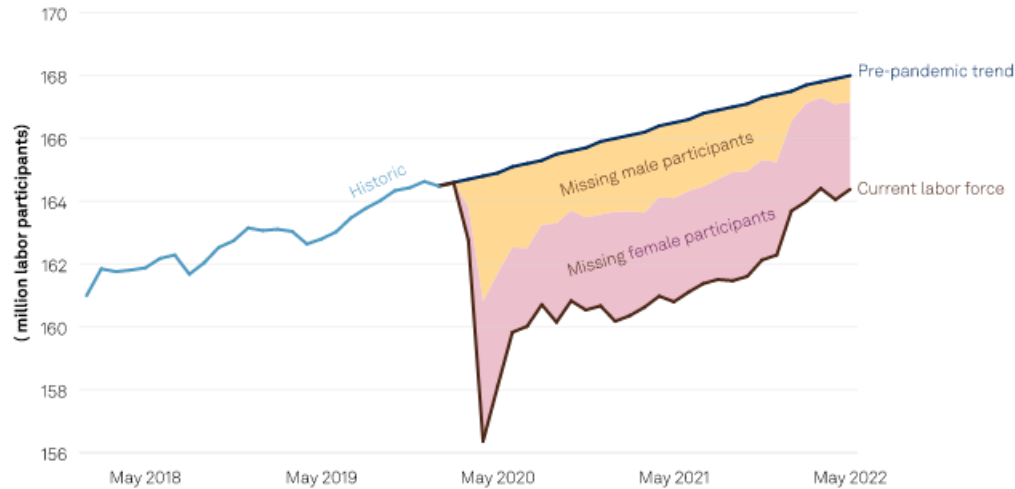

The pre-pandemic trend represents the people that would have been in the labor force had pre-pandemic conditions continued.
Sources: Bureau of Labor Statistics and S&P Global Ratings Economics calculations
Copyright © 2022 by Standard & Poor's Financial Services LLC. All rights reserved.

- Workforce gap could slow economic growth
- Wage competition exacerbating inflation

Consumers Are Spending More To Purchase Fewer Items

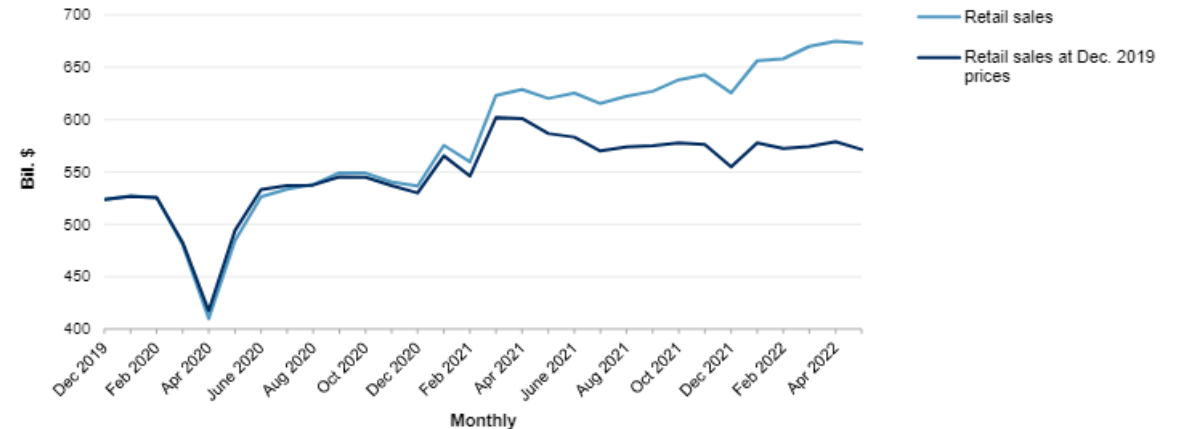

Sources: U.S. Census and S&P Global Economics calculations.
Copyright © 2022 by Standard & Poor's Financial Services LLC. All rights reserved.

- Higher sales tax in short term, but less purchasing power could reduce spending

East North Central Region: Low growth

Comparison Of S&P Global Market Intelligence Regional Forecasts: 2022

	Strongest	Mid-range	Weakest
	GDP growth (%)	Unemployment rate (%)	Core CPI
New England	2.0	3.9	7.9
Middle Atlantic	1.2	4.5	7.6
South Atlantic	1.6	3.4	7.8
East South Central	1.1	3.6	7.7
East North Central	0.8	3.9	7.7
West North Central	0.1	2.8	7.7
West South Central	2.2	4.1	8.0
Mountain	1.4	3.6	7.6
Pacific	2.0	4.6	7.6

Source: S&P Global Ratings
Copyright © 2022 by Standard & Poor's Financial Services LLC. All rights reserved.

East North Central

Consumer Price Index	1.5	1.0	5.2	7.7	3.2
Home price, existing median	5.1	7.6	14.3	15.2	7.8
Home price, existing median (\$)	184,157	198,107	226,353	260,741	281,119
Housing starts, total private	(2.3)	14.0	9.0	0.1	(1.7)
Housing starts, total private (000)	96	109	119	120	117
Real GSP growth	0.8	(4.1)	5.2	0.8	1.2
Real retail sales	1.0	2.8	13.9	0.3	(2.3)
Unemployment rate	3.8	8.5	5.2	3.9	4.5

Source: S&P Global Market Intelligence

Housing Market

We Expect Home Prices Will Continue To Climb
Median sales price of houses sold in the U.S.

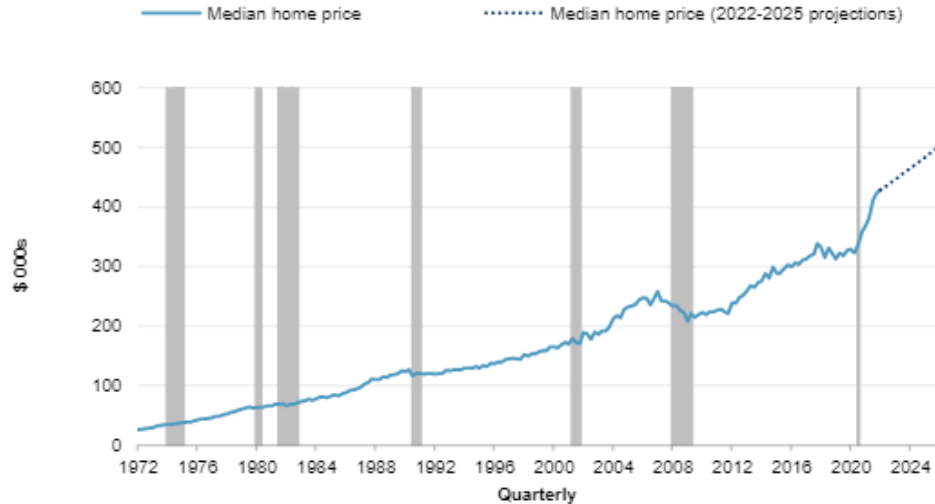

Shaded areas indicate periods of recession as defined by the National Bureau of Economic Research. Prices are for new, single-family houses and could be higher than prices of comparable existing homes by a small margin. Home prices are projected to grow at the same rate as the U.S. Census Bureau House Price Index. Sources: U.S. Census Bureau, U.S. Department of Housing and Urban Development, and S&P Global forecasts.
Copyright © 2022 by Standard & Poor's Financial Services LLC. All rights reserved.

- S&P/Case-Shiller U.S. National Home Price Index on upward trend
- Demand-supply imbalance will lead to further price appreciation

Number Of Years To Save For Down Payments, First-Time Homebuyers

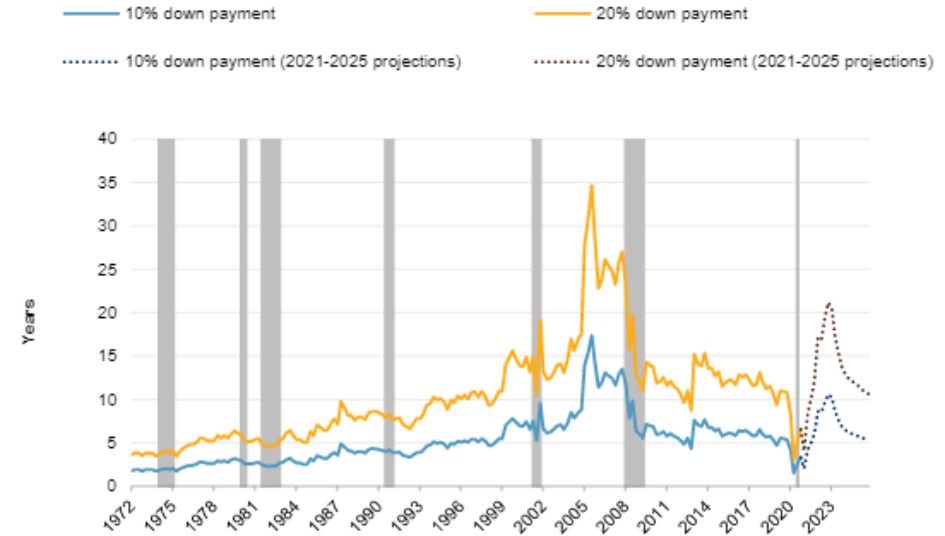

Shaded areas indicate periods of recession as defined by the National Bureau of Economic Research. Sources: U.S. Census Bureau, U.S. Department of Housing and Urban Development, Freddie Mac, U.S. Bureau of Economic Analysis, Federal Reserve Bank of St. Louis, and S&P Global calculations.
Copyright © 2022 by Standard & Poor's Financial Services LLC. All rights reserved.

- Housing affordability on the decline
- No immediate impact on local governments expected

What We're Watching - Local Government

U.S. could suffer hard landing

Key Risks We're Watching

-  How the housing market fares given rising interest rates
-  A recession (or recessionary pressures) translates to a pullback on consumer spending or pushes up unemployment
-  The level of credit instability a prolonged period of economic pressure could generate

Sustained cost pressures and ongoing supply chain disruptions threaten credit quality

Key Risks We're Watching

-  The ability to increase taxes or other revenues to offset long term operating cost growth created by prolonged high inflation
-  If rising costs delay or limit projects being funded with ARPA money
-  How price sensitivity for goods and services affects operational balance

Prolonged high inflation

Key Risks We're Watching

-  Delayed projects or higher costs for construction could affect operations and capital plans
-  Limitations on rate-setting ability given inflation
-  Shifts in the housing market that slow, or stop, tax base growth

Ongoing equity market volatility

Key Risks We're Watching

-  Stagnating or falling capital gains tax revenues at the state level
-  State revenue shortfalls that lead to revenue sharing cuts for local governments
-  If market losses in 2022 wipe out any 2021 gains needed to boost low pension funding levels

What We're Watching - Ohio

Municipality reliance on income taxes and effects from remote working

County reliance on sales tax and effects from inflation

Diversification of employment base (e.g., Intel)

Manufacturing sector

Oil/gas industry

Tourism/hospitality industry

State's credit (AA+/Stable) and budget cycle

Gubernatorial race

Aging infrastructure

Clean water

Slow population growth, lack of in-migration

What else?

Hot Topics: ESG, Pensions, & Cyber

ESG In Credit Ratings | **Materiality Is Key**

The materiality of ESG factors varies by sector and region and may or may not be relevant in our rating analysis.

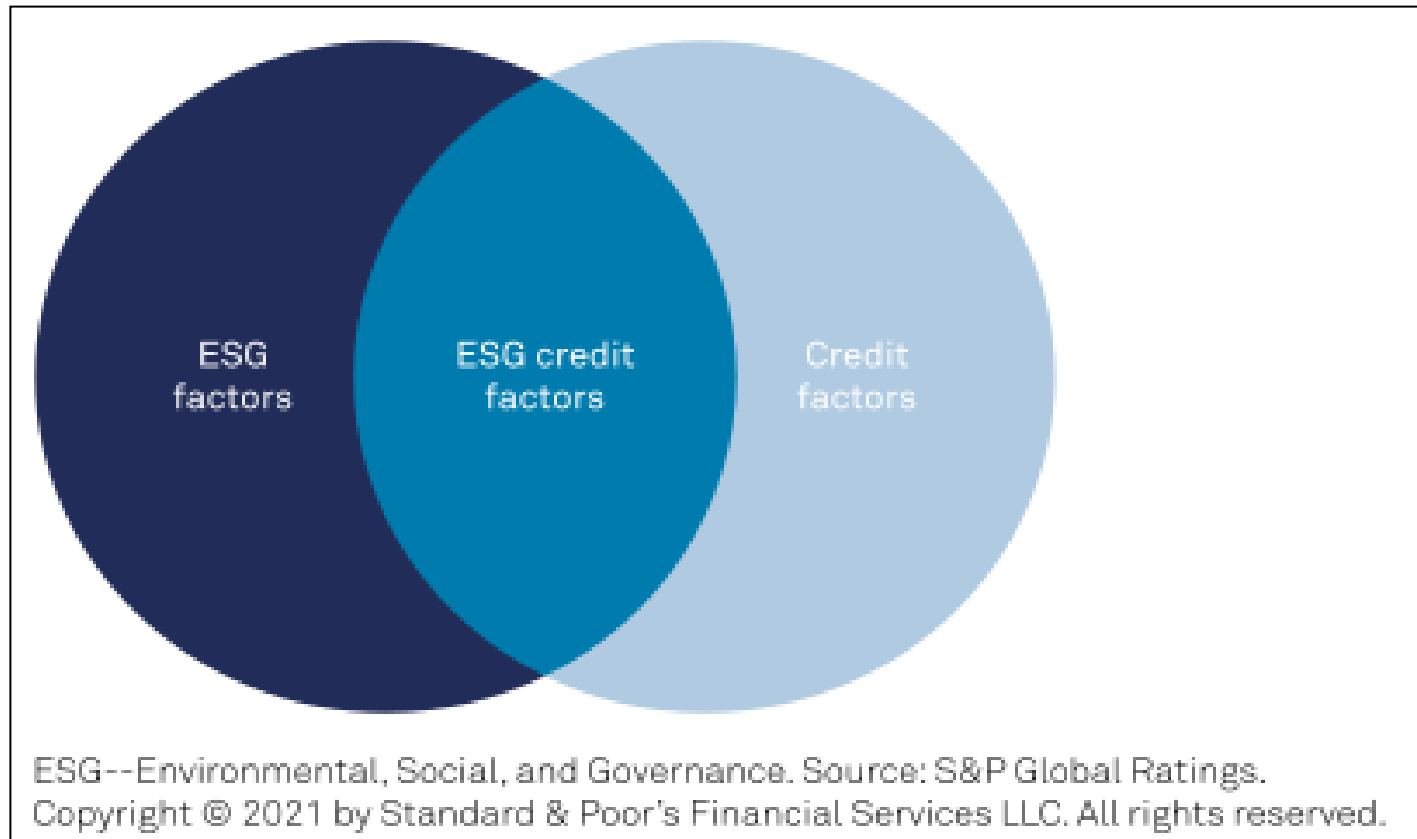

- ESG factors incorporate an entity's impact from, and effect on the natural and social environment and the quality of its governance.
- **Not all ESG factors materially influence creditworthiness.**
- **ESG credit factors** are those ESG factors that can **materially influence the creditworthiness** of a rated entity and for which we have **sufficient visibility and certainty** to include in our rating analysis.

Source: *Environmental, Social, And Governance Principles In Credit Ratings*, published Oct. 10, 2021

ESG Principles Criteria | General Principles of ESG Factors & Ratings

Environmental factors



Climate transition risks



Physical risks



Natural capital



Waste and pollution



Other environmental factors

Social factors



Health and safety



Social capital



Human capital



Other social factors

Governance factors

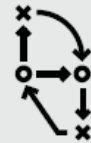

Governance structure



Risk management, culture, and oversight



Transparency and reporting



Other governance factors

Principle One

Our long-term issuer credit ratings do not have a pre-determined time horizon.

Principle Two

The current and potential future influence of ESG credit factors on creditworthiness can differ by industry, geography, and entity.

Principle Three

The direction of and visibility into ESG credit factors may be uncertain and can change rapidly.

Principle Four

The influence of ESG credit factors may change over time, which is reflected in the dynamic nature of our credit ratings.

Principle Five

Strong creditworthiness does not necessarily correlate with strong ESG credentials and vice versa.

ESG--Environmental, social, and governance, Source: S&P Global Ratings.
Copyright © 2021 by Standard & Poor's Financial Services LLC. All rights reserved.

Environmental

Waste and pollution

Lead Service Lines Per 1,000 People

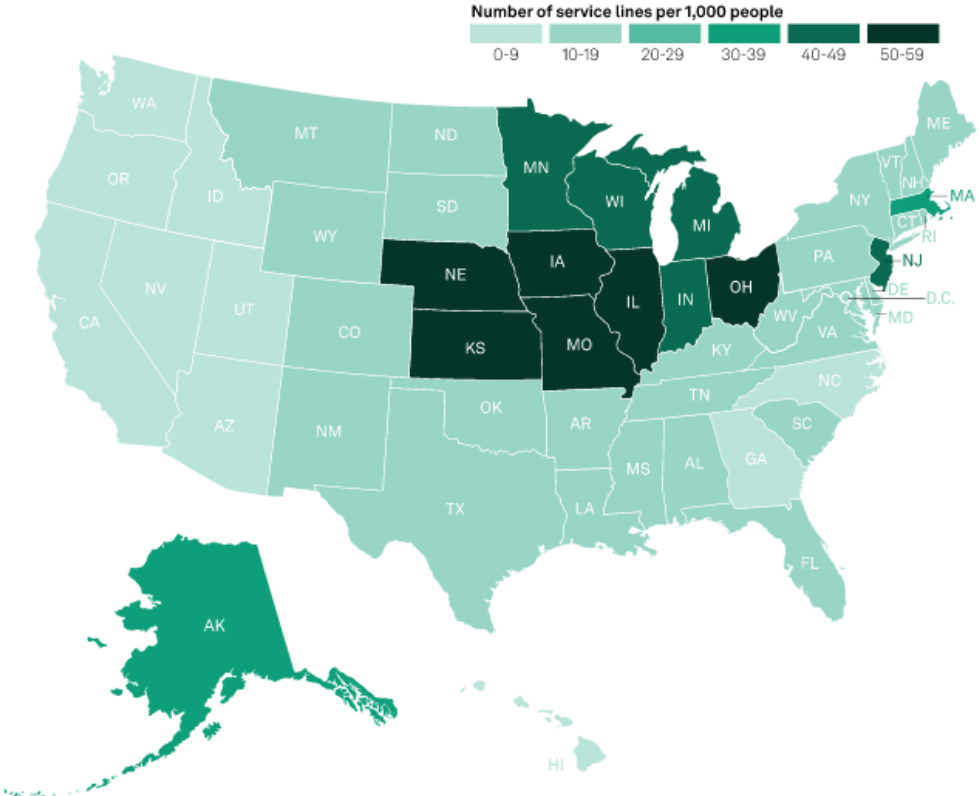

Source: EPA. Copyright © 2022 by Standard & Poor's Financial Services LLC. All rights reserved.

Physical

Federal Disaster Declarations Per Year In The Midwest And Central States

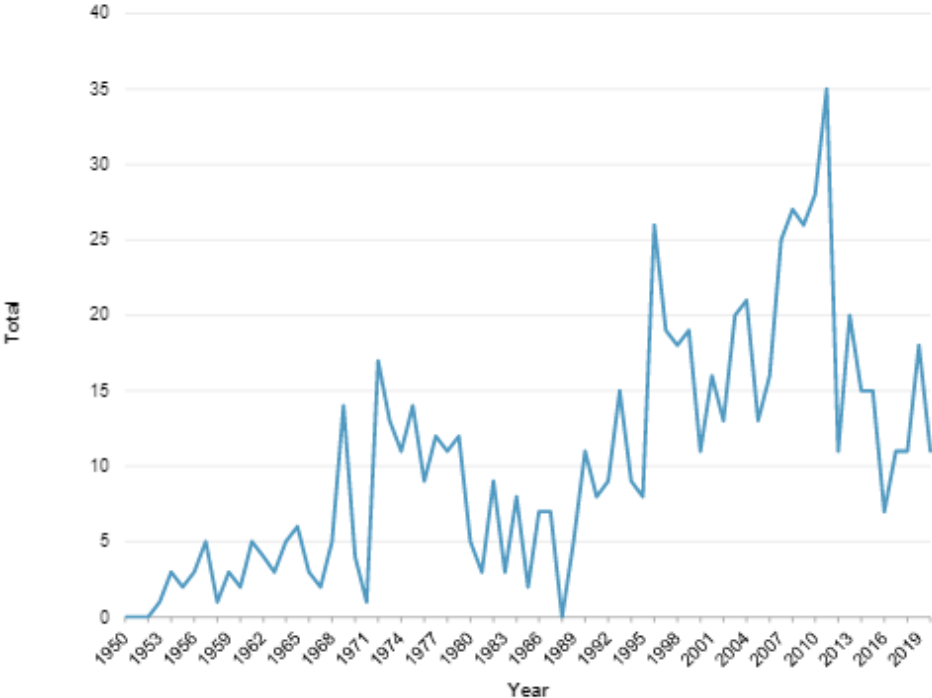

Source: Federal Emergency Management Agency

Environmental

Transition Risk

High Concentration Of Non-EV Auto Plants In Midwest And Central Region

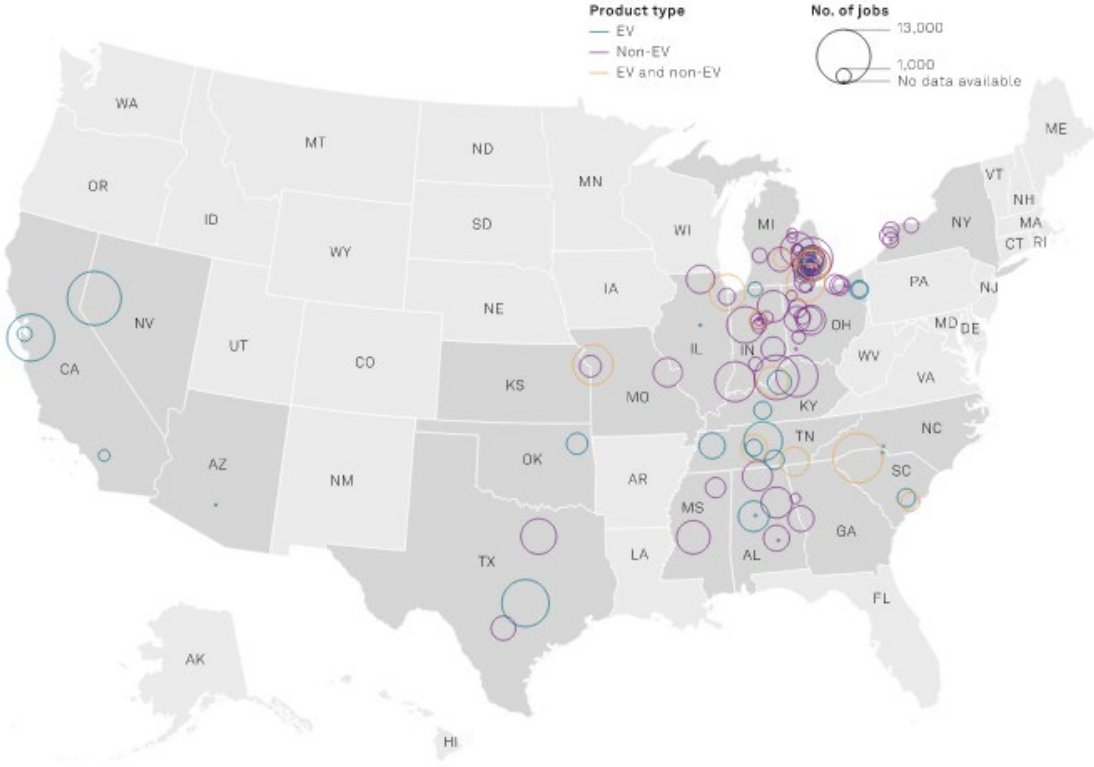

Source: Third Way.
Copyright © 2022 by Standard & Poor's Financial Services LLC. All rights reserved.

Opportunity



Social

Social Capital

Projected Increase In Old-Age Dependency Ratios Over The Next 20 Years

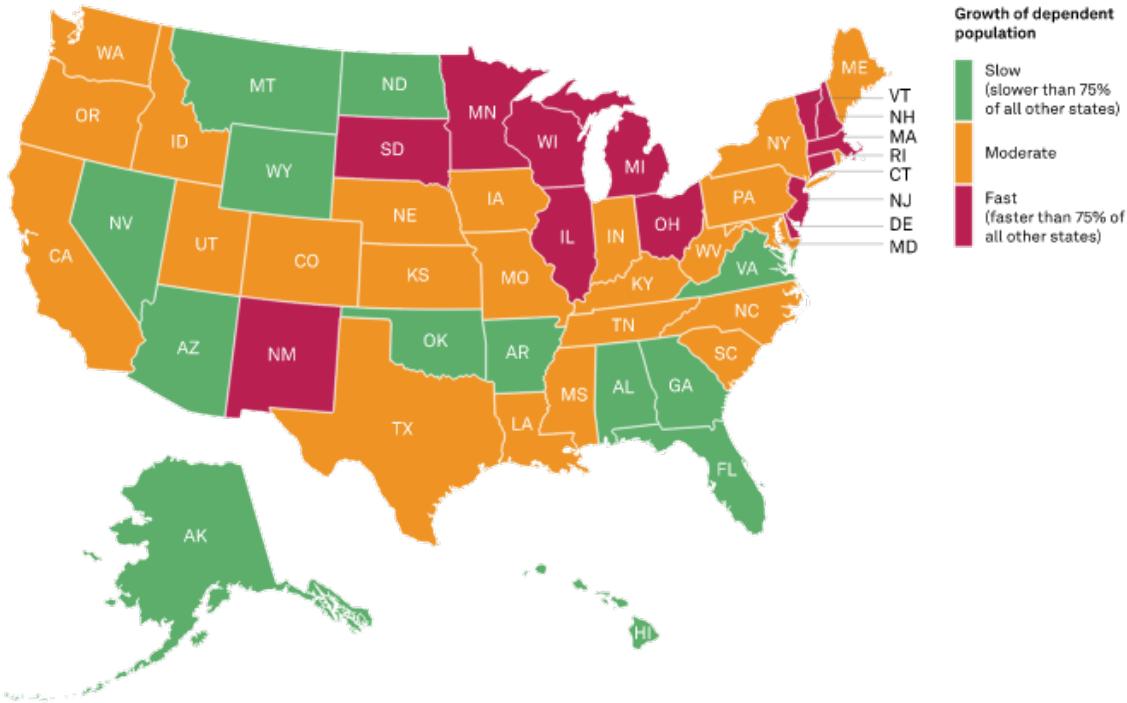

Sources: S&P Global Ratings, S&P Global Market Intelligence. Copyright © 2022 by Standard & Poor's Financial Services LLC. All rights reserved.

Social Capital

Historical And Projected Population Growth In The Midwest And Central Region

	2020 pop.	2025 pop. (proj.)	--Growth, 2010-2020--		--Projected growth, 2010-2025--	
			Percent	Relative to the U.S.	Percent	Relative to the U.S.
Iowa	3,189,055	3,229,508	4.43	Weaker	1.27	Weaker
Illinois	12,768,951	12,453,334	(0.64)	Weaker	(2.47)	Weaker
Indiana	6,788,931	6,927,976	4.52	Weaker	2.05	Stronger
Kentucky	4,504,843	4,561,480	3.53	Weaker	1.26	Weaker
Michigan	10,065,932	10,050,194	1.84	Weaker	(0.16)	Weaker
Minnesota	5,706,635	5,798,975	7.32	Stronger	1.62	Weaker
Missouri	6,156,723	6,232,147	2.66	Weaker	1.23	Weaker
North Dakota	778,272	785,019	15.01	Stronger	0.87	Weaker
Ohio	11,789,673	11,835,831	2.13	Weaker	0.39	Weaker
Pennsylvania	12,986,292	13,005,731	2.06	Weaker	0.15	Weaker
South Dakota	887,866	926,166	8.68	Stronger	4.31	Stronger
Wisconsin	5,892,503	5,948,691	3.47	Weaker	0.95	Weaker
West Virginia	1,789,303	1,754,707	(3.52)	Weaker	(1.93)	Weaker
Region avg.	83,304,979	83,509,760	3.96	Weaker	0.73	Weaker
U.S. avg.	331,533,230	337,554,290	6.70		1.90	

Source: S&P Global Market Intelligence

Social

Human Capital

Manufacturing Contribution To GSP And Employment		
Percent of total		
	To GSP	To employment
Illinois	12.3	9.7
Indiana	25.3	16.9
Iowa	17.3	14.4
Kentucky	0.8	12.8
Michigan	17.5	13.8
Minnesota	13.1	11.1
Missouri	11.8	9.6
North Dakota	7.1	6.1
Ohio	15.5	12.4
Pennsylvania	12.2	9.6
South Dakota	8.3	10.2
West Virginia	9.4	6.6
Wisconsin	18.1	16.3
U.S.	10.9	8.6

Source: Bureau of Labor Statistics

Human Capital

Resident Employment Growth

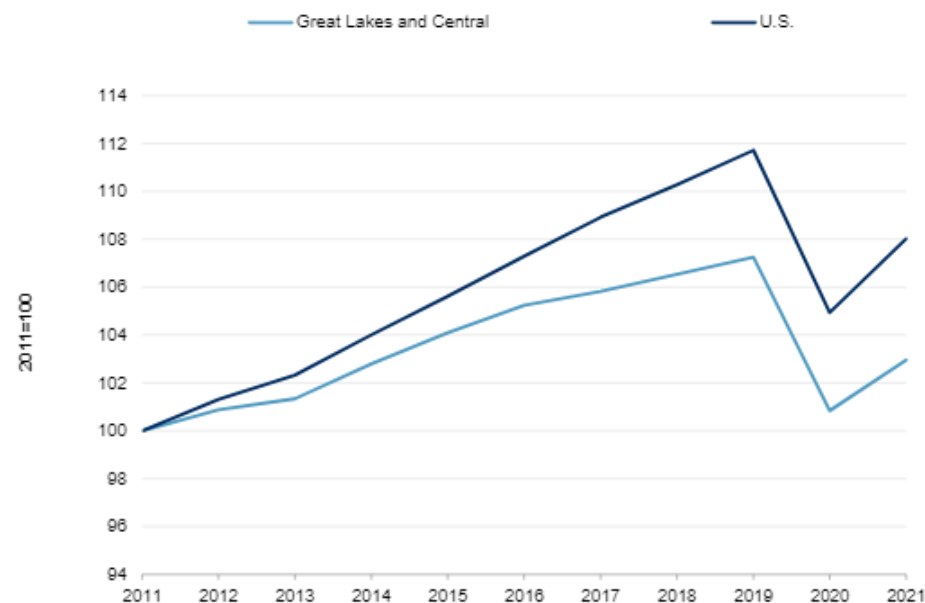

Source: Bureau of Labor Statistics (total nonfarm employment, seasonally adjusted)
Copyright © 2022 by Standard & Poor's Financial Services LLC. All rights reserved.

ESG U.S. Public Finance Report Card: Midwest And Central Region Governments and Not-For-Profit Enterprises, published July 13, 2022

Pensions

Aggregate U.S. State-Funded Ratios For Fiscal 2021 - Pension

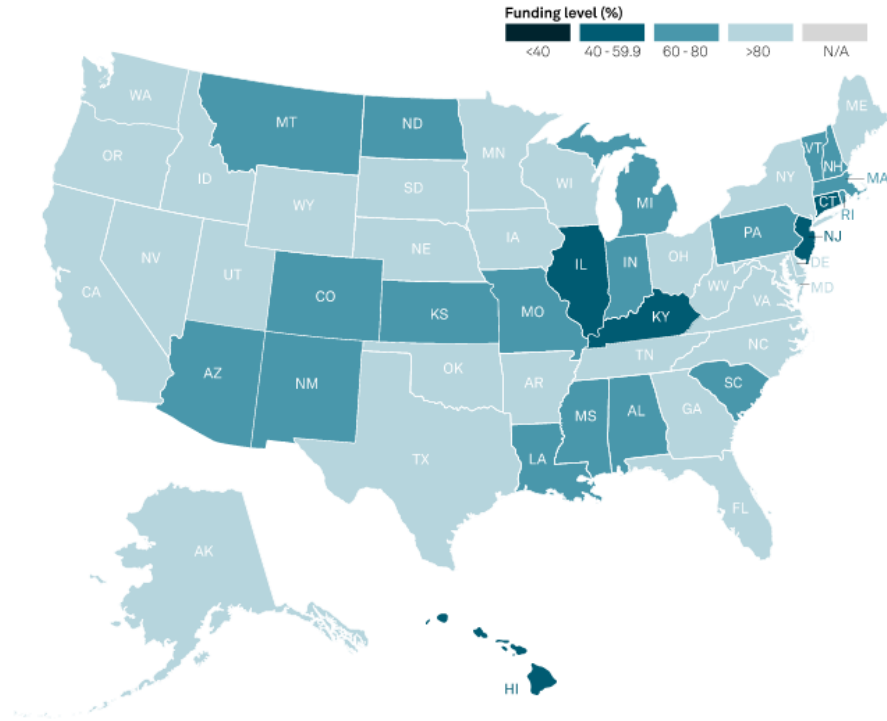

N/A--Not applicable. Source: S&P Global Ratings.
Copyright © 2022 by Standard & Poor's Financial Services LLC. All rights reserved.

State Pension Plan Aggregate Actual Contribution Funding Progress

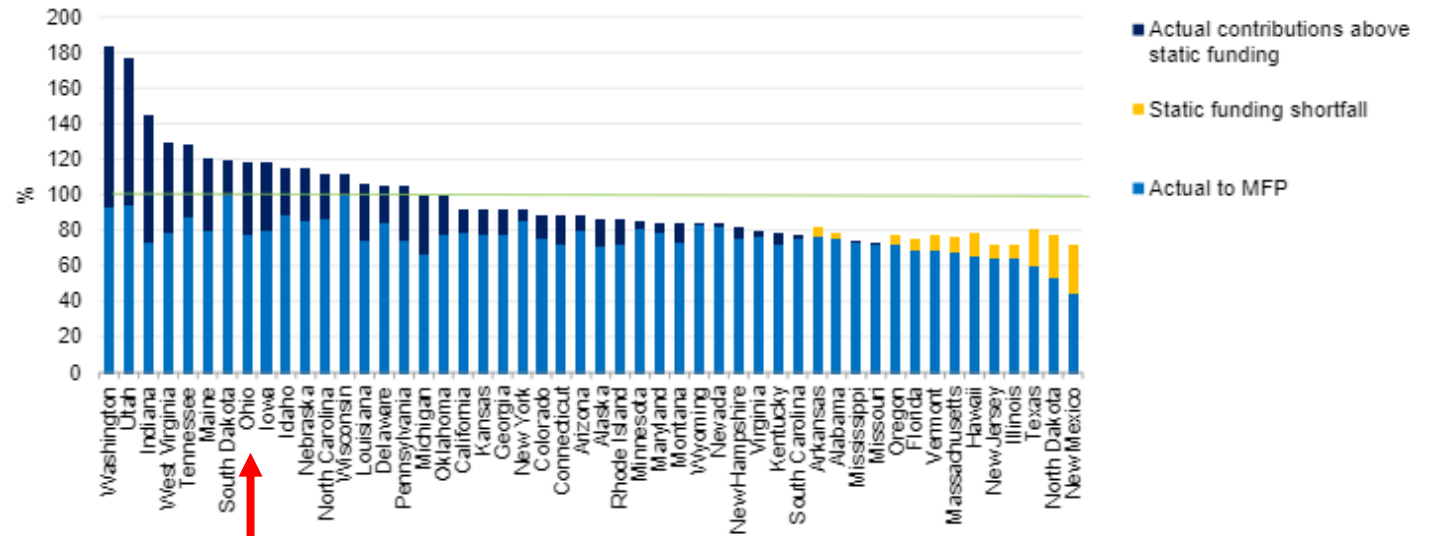

MFP--Minimum funding progress.

Copyright © 2022 by Standard & Poor's Financial Services LLC. All rights reserved.

OPEB

Aggregate U.S. State-Funded Ratios For Fiscal 2021 - OPEB

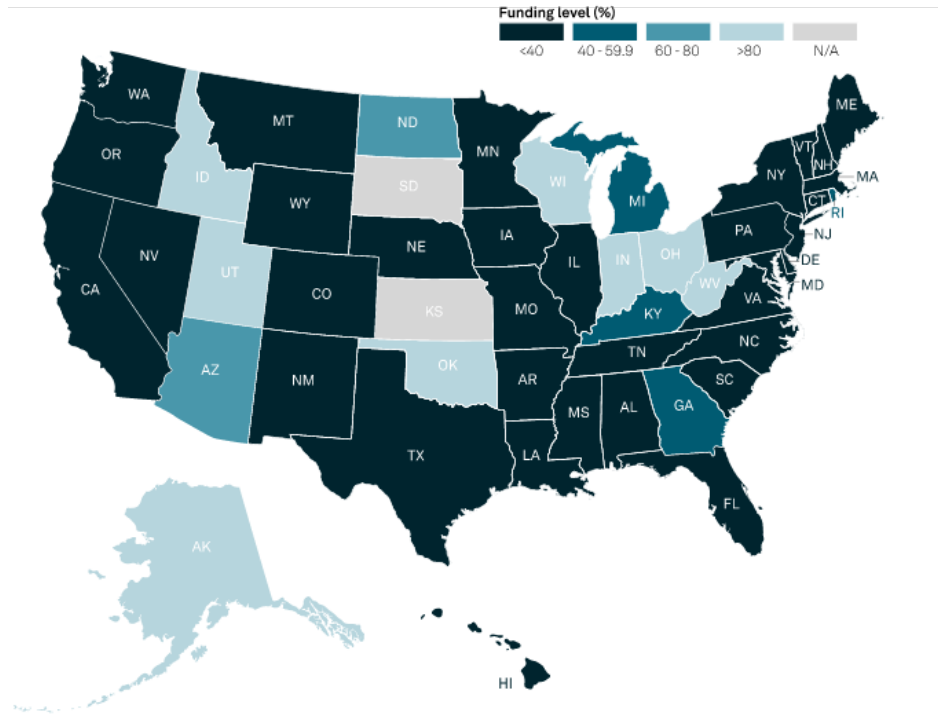

We have excluded Kansas and South Dakota from this chart because these states do not report a liability for retiree health care benefits. OPEB--Other postemployment benefits. N/A--Not applicable. Source: S&P Global Ratings. Copyright © 2022 by Standard & Poor's Financial Services LLC. All rights reserved.

State OPEB Plan Aggregate Actual Contribution Funding Progress

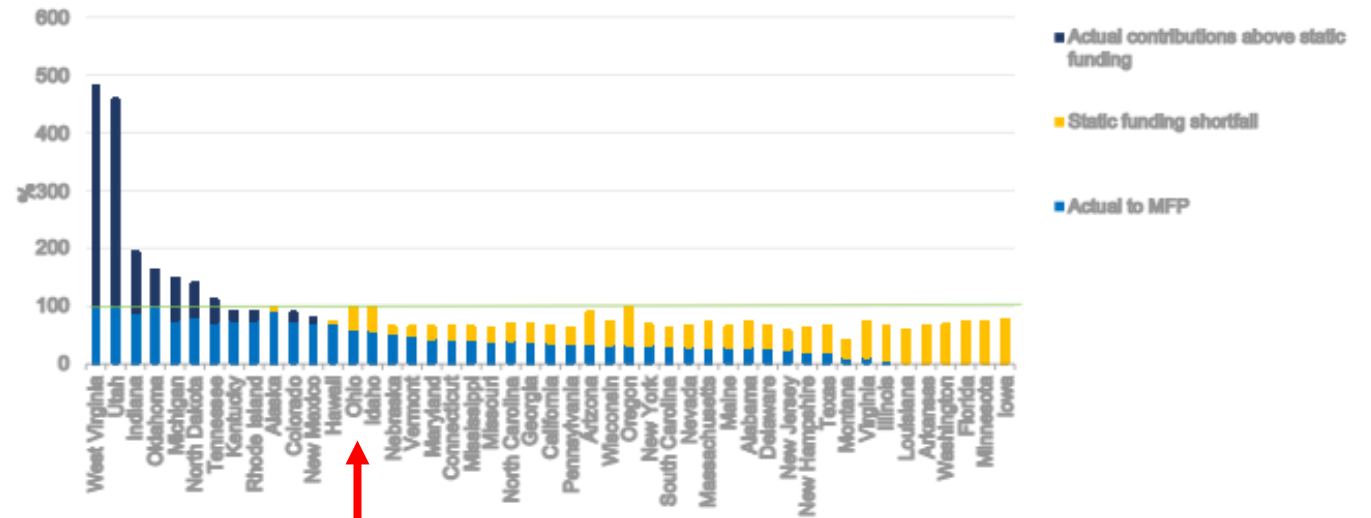

OPEB--Other postemployment benefits. MFP- Minimum funding progress. Kansas and South Dakota are excluded because they do not report a liability for retiree health care benefits. Wyoming is excluded because a schedule of changes to the net OPEB liability (NOL) was not publicly available. California's Trial Courts plan is excluded from our calculation of static funding and minimum funding progress for California because the state does not disclose schedule of changes to the NOL for the numerous trial courts reported as a part of the primary government in its annual comprehensive financial report.

Copyright © 2022 by Standard & Poor's Financial Services LLC. All rights reserved.

Pension Overview: Ohio



Funded
ratio



Assumed rate
of return



Funding
plan



Minimum funding
progress last year

	Funded ratio	Assumed rate of return	Funding plan	Minimum funding progress last year
OPERS				
OP&F				
STRS				
SERS				

OPERS—Ohio Public Employees Retirement System, OP&F—Ohio Police & Fire Pension Fund.

STRS—State Teachers Retirement System, SERS—School Employees Retirement System.

Source: S&P Global Ratings.

Copyright © 2020 by Standard & Poor's Financial Services LLC. All rights reserved.

Pension Spotlight: Ohio, published Jan. 7, 2021

Cyber Risk

What We're Watching



Prepare

- ✓ Identify areas of risk
- ✓ Protect assets and data



Respond

- ✓ Detect and respond to an attack



Recover

- ✓ Recover data
- ✓ Maintain sufficient liquidity
- ✓ Disclose attacks

Source: S&P Global Ratings.

Copyright © 2021 by Standard & Poor's Financial Services LLC. All rights reserved.

ESG Brief: Cyber Risk Management In U.S. Public Finance, published June 28, 2021

Q&A

S&P Global
Ratings

Appendix

S&P Global
Ratings

S&P Global's Ratings Scale

Investment-Grade

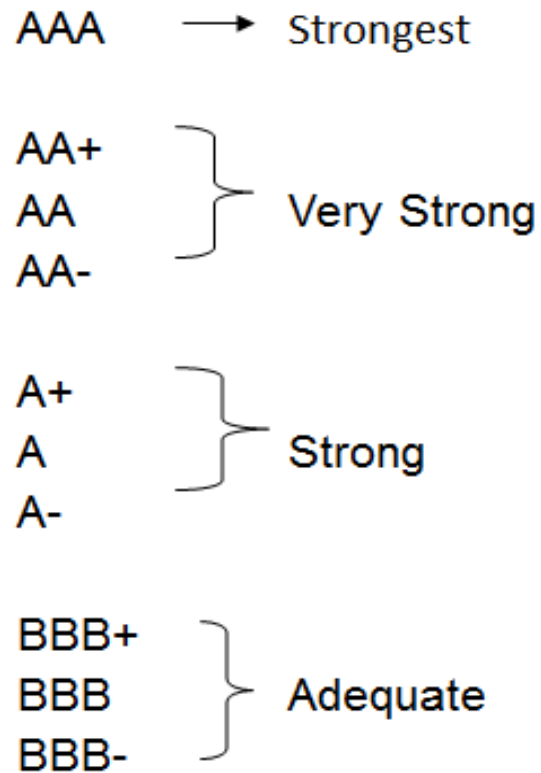

Speculative-Grade

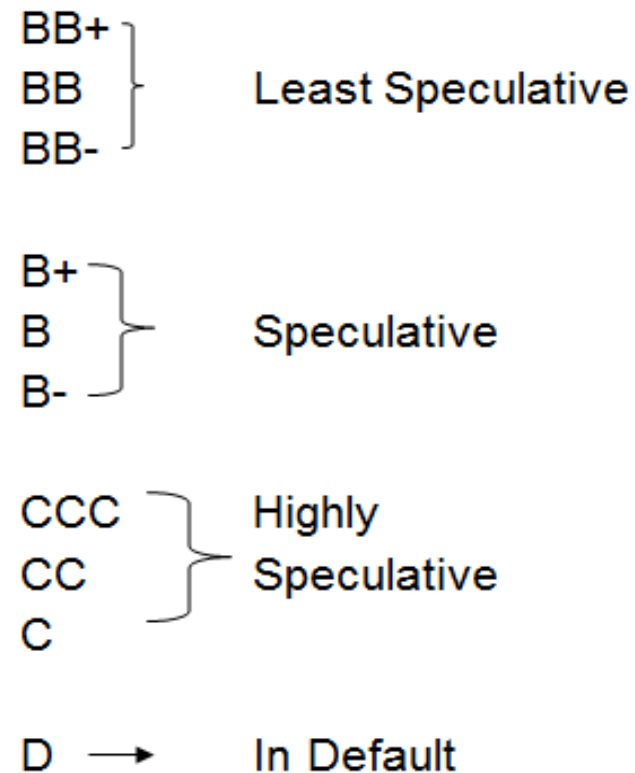

Short-term U.S. Public Finance note ratings: **SP-1+, SP-1, SP-2 & SP-3**

Outlooks and CreditWatch

• Outlooks

- Potential rating change within 1 to 2 years
- At least 1-in-3 likelihood of rating action
- Outlooks can be:
 - Stable
 - Positive
 - Negative
 - Developing

• CreditWatch

- Potential rating change within 60 to 90 days
- At least 1-in-2 likelihood of rating action
- CreditWatch can be:
 - Positive
 - Negative
 - Developing

Overall Analytical Framework Local Government

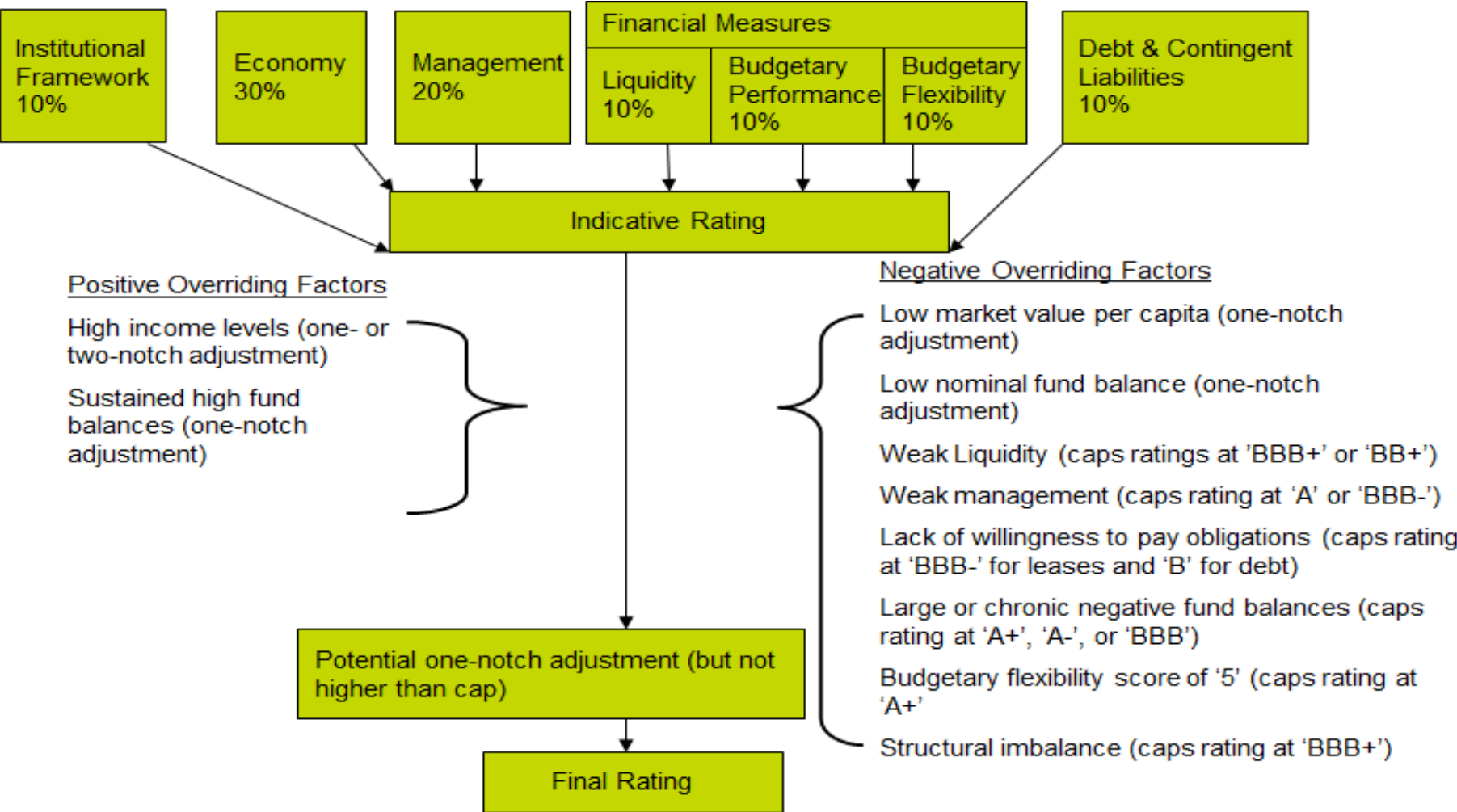

Copyright © 2022 by Standard & Poor's Financial Services LLC. All rights reserved.

No content (including ratings, credit-related analyses and data, valuations, model, software or other application or output therefrom) or any part thereof (Content) may be modified, reverse engineered, reproduced or distributed in any form by any means, or stored in a database or retrieval system, without the prior written permission of Standard & Poor's Financial Services LLC or its affiliates (collectively, S&P). The Content shall not be used for any unlawful or unauthorized purposes. S&P and any third-party providers, as well as their directors, officers, shareholders, employees or agents (collectively S&P Parties) do not guarantee the accuracy, completeness, timeliness or availability of the Content. S&P Parties are not responsible for any errors or omissions (negligent or otherwise), regardless of the cause, for the results obtained from the use of the Content, or for the security or maintenance of any data input by the user. The Content is provided on an "as is" basis. S&P PARTIES DISCLAIM ANY AND ALL EXPRESS OR IMPLIED WARRANTIES, INCLUDING, BUT NOT LIMITED TO, ANY WARRANTIES OF MERCHANTABILITY OR FITNESS FOR A PARTICULAR PURPOSE OR USE, FREEDOM FROM BUGS, SOFTWARE ERRORS OR DEFECTS, THAT THE CONTENT'S FUNCTIONING WILL BE UNINTERRUPTED, OR THAT THE CONTENT WILL OPERATE WITH ANY SOFTWARE OR HARDWARE CONFIGURATION. In no event shall S&P Parties be liable to any party for any direct, indirect, incidental, exemplary, compensatory, punitive, special or consequential damages, costs, expenses, legal fees, or losses (including, without limitation, lost income or lost profits and opportunity costs or losses caused by negligence) in connection with any use of the Content even if advised of the possibility of such damages.

Credit-related and other analyses, including ratings, and statements in the Content are statements of opinion as of the date they are expressed and not statements of fact. S&P's opinions, analyses, and rating acknowledgment decisions (described below) are not recommendations to purchase, hold, or sell any securities or to make any investment decisions, and do not address the suitability of any security. S&P assumes no obligation to update the Content following publication in any form or format. The Content should not be relied on and is not a substitute for the skill, judgment and experience of the user, its management, employees, advisors and/or clients when making investment and other business decisions. S&P does not act as a fiduciary or an investment advisor except where registered as such. While S&P has obtained information from sources it believes to be reliable, S&P does not perform an audit and undertakes no duty of due diligence or independent verification of any information it receives. Rating-related publications may be published for a variety of reasons that are not necessarily dependent on action by rating committees, including, but not limited to, the publication of a periodic update on a credit rating and related analyses.

To the extent that regulatory authorities allow a rating agency to acknowledge in one jurisdiction a rating issued in another jurisdiction for certain regulatory purposes, S&P reserves the right to assign, withdraw, or suspend such acknowledgement at any time and in its sole discretion. S&P Parties disclaim any duty whatsoever arising out of the assignment, withdrawal, or suspension of an acknowledgement as well as any liability for any damage alleged to have been suffered on account thereof.

S&P keeps certain activities of its business units separate from each other in order to preserve the independence and objectivity of their respective activities. As a result, certain business units of S&P may have information that is not available to other S&P business units. S&P has established policies and procedures to maintain the confidentiality of certain nonpublic information received in connection with each analytical process.

S&P may receive compensation for its ratings and certain analyses, normally from issuers or underwriters of securities or from obligors. S&P reserves the right to disseminate its opinions and analyses. S&P's public ratings and analyses are made available on its Web sites, www.standardandpoors.com (free of charge), and www.spcapitaliq.com (subscription) and may be distributed through other means, including via S&P publications and third-party redistributors. Additional information about our ratings fees is available at www.standardandpoors.com/usratingsfees.

Australia: S&P Global Ratings Australia Pty Ltd holds Australian financial services license number 337565 under the Corporations Act 2001. S&P Global Ratings' credit ratings and related research are not intended for and must not be distributed to any person in Australia other than a wholesale client (as defined in Chapter 7 of the Corporations Act).

STANDARD & POOR'S, S&P and RATINGSDIRECT are registered trademarks of Standard & Poor's Financial Services LLC.

spglobal.com/ratings